

FORMAS

A base para toda obra



www.spformas.com.br



PAINÉIS COM CHAVETAS FIXAS



FACILIDADE NA MONTAGEM E GANHO DE PRODUTIVIDADE

A **SP FORMAS**, fundada em 1993, consolida-se cada vez mais no mercado pela sua filosofia de trabalho e pela manutenção de sua meta principal, focada na **satisfação de todos os seus clientes**. Este é o resultado do bom atendimento em todas as etapas da obra e de um sistema interno totalmente automatizado que permite rapidez na troca de todas as informações com os clientes.

Por sua experiência, está preparada para executar projetos, cronogramas, formação e supervisão de obras, com relatórios produtivos direcionados a atingir todas as metas do cliente.

Os painéis da **SP FORMAS** são compostos de uma estrutura metálica em aço especial SAC 41, e o contato com o concreto dar-se-á através de uma placa estrutural impermeável e polida que produz uma superfície espelhada, resultando em um concreto aparente.

Em 2002, a **SP FORMAS** lançou no mercado o inovador painel SPFN, que conta com chavetas fixas e de uso **totalmente manual**, tornando-se a pioneira no uso deste modelo.

Os painéis são rapidamente interligados uns aos outros por chavetas presas à sua estrutura, evitando assim a sua perda. Este sistema visa obter ganhos de produtividade na montagem e desmontagem das formas.

Os painéis da **SP FORMAS** são leves e de utilização abrangente na confecção de **pilares, vigas, lajes, paredes, galerias, canais, E.T.E. e E.T.A.**, entre outros, tanto os de pré-moldagem quanto os de moldagem 'in loco'.



TERMINAL DE CARGA AÉREO
AEROPORTO INTERNACIONAL - RJ



FUNDAÇÕES
LINHA AMARELA - RJ



PAREDES
ESTÁDIO OLÍMPICO JOÃO HAVELANGE - RJ

CARACTERÍSTICAS DO PAINEL SPF

- Sistema de chavetas fixas e travamento manual
- Possibilita a montagem de diversas seções de concreto
- A superfície por ser perfeitamente plana e polida dá ao concreto um acabamento ideal para grandes obras
- Possui maior resistência estrutural por ser fabricado em perfil 'U' enrijecido e em aço especial SAC 41
- As laterais do painel possuem 10 cm de largura proporcionando um alinhamento automático das faces das formas
- É ecologicamente correto por usar uma chapa fenólica que pode ser reaproveitada diversas vezes
- É mais resistente a intempéries como chuva e umidade



VIGAS
ESTÁDIO OLÍMPICO JOÃO HAVELANGE - RJ



PILAR CIRCULAR
PAINÉIS MONTADOS E ESTRUTURA CONCRETADA

PILARES, VIGAS E LAJES

RAPIDEZ NA MONTAGEM E
REDUÇÃO NO ESCORAMENTO



PILARES E VIGAS
CABO FRIO - RJ



PILAR RETANGULAR
PAINÉIS MONTADOS E ESTRUTURA CONCRETADA



PILARES E VIGAS
GARULHOS - SP



PILARES, VIGAS E LAJES
CLÍNICA ESCOLA DE CAMPOS DOS GOYTACAZES - RJ

TRAVESSAS

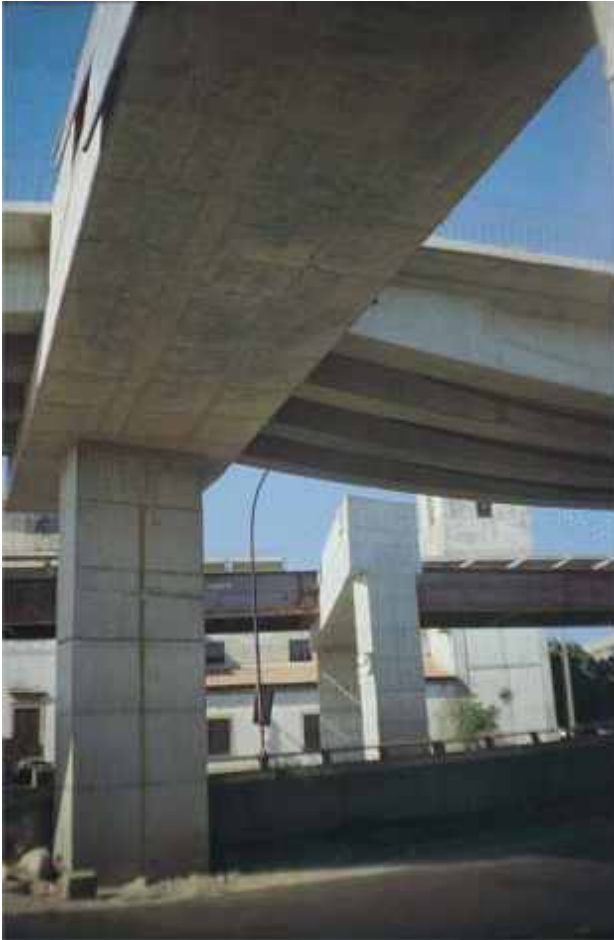

VIADUTO DE LIGAÇÃO
PONTE RIO-NITERÓI



LINHA AMARELA - AVENIDA BRASIL - RJ

A equipe técnica da SP FORMAS, formada por engenheiros e técnicos especializados, é capaz de fornecer soluções para qualquer tipo de obra.



LINHA AMARELA - RJ
1ª E 2ª ETAPAS DE CONCRETAGEM

RESERVATÓRIOS RETANGULARES



RESERVATÓRIO DO CABRAL
NILÓPOLIS - RJ



CEDAE
DUQUE DE CAXIAS - RJ

Os painéis da **SP FORMAS** agilizam a montagem, baixam o custo da mão de obra e se adequam a diversos formatos de reservatórios. Através de etapas de concretagem são atingidas grandes alturas sendo garantida a estanqueidade pelo uso do sistema de travamento de cones.



UNIVERSIDADE FEDERAL DO RIO DE JANEIRO



UNIVERSIDADE FEDERAL DO RIO DE JANEIRO

RESERVATÓRIOS CIRCULARES



REDUC - RJ

ALUNORTE
BARCARENA - PA

O sistema de travamento de formas, por meio dos cones com barras rosqueadas, possibilita total estanqueidade e uniformidade na espessura dos reservatórios. Além disso, os painéis especiais 'RE' e 'RI' dão o formato perfeitamente circular.

E.T.E. VIRGEM SANTA
MACAÉ - RJE.T.A. CAMPO LIMPO
CAMPO LIMPO PAULISTA - SP



TÚNEL
SANTANA DO PARNAÍBA - SP



NEW JERSEY

**OS PAINÉIS DA SP FORMAS SÃO
VERSÁTEIS E ADAPTÁVEIS ÀS MAIS
VARIADAS SEÇÕES DE
ESTRUTURAS DE CONCRETO,
PRODUZINDO UM PERFEITO
ACABAMENTO**



PILARES
VIA LIGHT - NOVA IGUAÇU - RJ



BRITADOR
SANTANA DO PARNAÍBA - SP



BARRAGEM DE ARRAIAS
TOCANTIS



RESERVATÓRIO CIRCULAR
ITABIRITO - MG



VIGAS PROTENDIDAS
PONTE - BR 101 - RJ



CONCHA ACÚSTICA
RIO DAS OSTRAS - RJ



TIPOS DE MONTAGEM

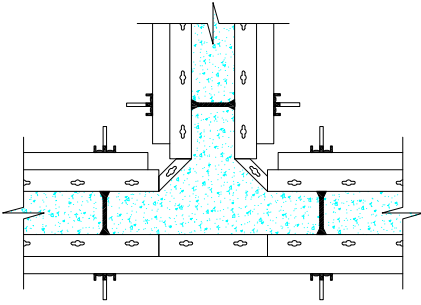

PAREDE EM 'T' COM MÍSULA

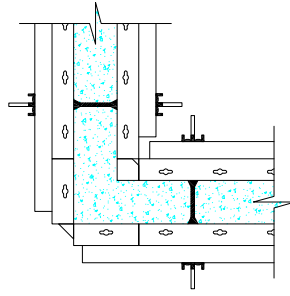

PAREDE EM 'L'

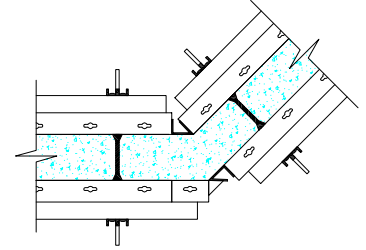

PAREDE EM 45°

VIGAS PRÉ-MOLDADAS

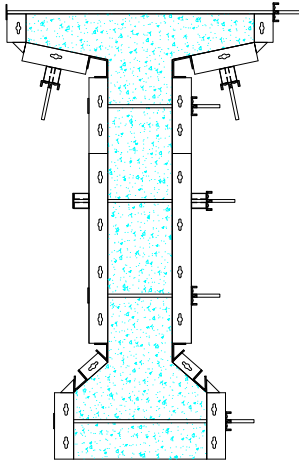

NEW JERSEY

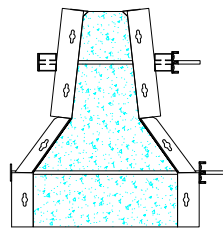

PAREDE CIRCULAR

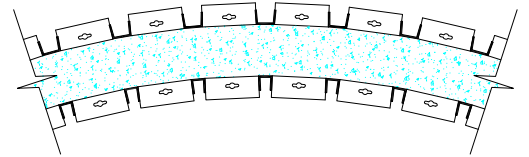

ETAPAS DE CONCRETAGEM

1ª ETAPA

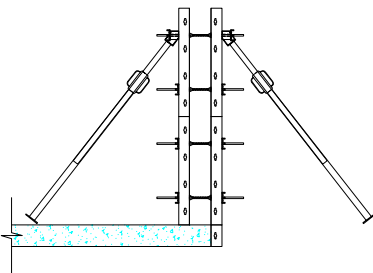

2ª ETAPA

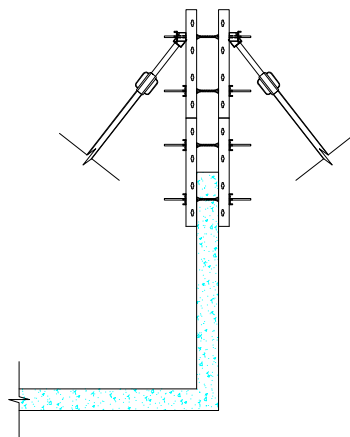

3ª ETAPA
LAJE COM BEIRAL

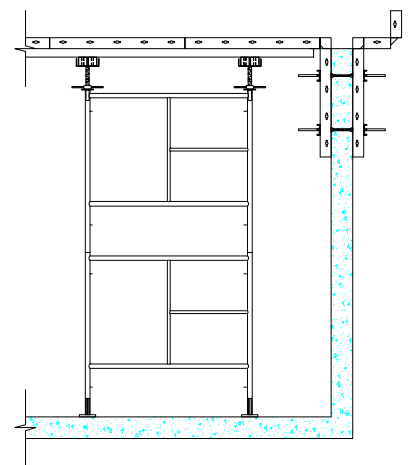









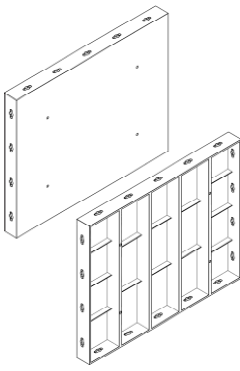
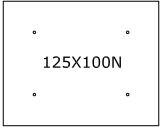



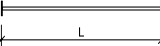

PROJETOS SIMPLES QUE DEMONSTRAM
COM EXATIDÃO A MONTAGEM DOS PAINÉIS,
SEUS ACESSÓRIOS E AS ETAPAS DE CONCRETAGEM
DEFINIDAS NO PROCESSO EXECUTIVO.







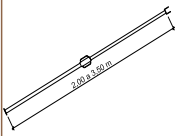
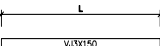



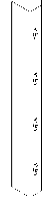
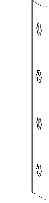
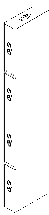
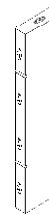

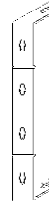

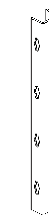

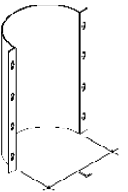

PAINÉIS E ACESSÓRIOS



PAINEL SPF	REPRESENTAÇÃO	DIMENSÕES (cm)	PESO (kg)
	 <p>VISTA FRONTAL</p>  <p>VISTA LATERAL</p>  <p>VISTA LATERAL</p>	SPF 125 x 100	32,00
		SPF 100 x 100	29,00
		SPF 90 x 100	22,50
		SPF 80 x 100	21,00
		SPF 70 x 100	17,00
		SPF 60 x 100	15,00
		SPF 50 x 100	12,80
		SPF 45 x 100	12,00
		SPF 40 x 100	9,50
		SPF 35 x 100	8,70
		SPF 30 x 100	7,90
		SPF 25 x 100	7,20
		SPF 21 x 100	7,15
		SPF 20 x 100	7,10
		SPF 19 x 100	6,90
		SPF 18 x 100	6,80
SPF 17 x 100	6,60		
SPF 16 x 100	6,40		
SPF 15 x 100	6,30		
SPF 14 x 100	6,10		
SPF 13 x 100	6,00		
SPF 12 x 100	5,80		
SPF 11 x 100	5,70		
SPF 10 x 100	5,50		
SPF 9 x 100	5,30		

ACESSÓRIOS	REPRESENTAÇÃO	DIMENSÕES (cm)	PESO (kg)
TIRANTE		SPT 5/8" x 75	1,17
		SPT 5/8" x 100	1,56
		SPT 5/8" x 130	2,00
		SPT 5/8" x 150	2,30
		SPT 5/8" x 175	2,70
CONE			0,40
GANCHO			0,40
PORCA	 <p>VISTA FRONTAL</p>  <p>VISTA LATERAL</p>		0,20
CHAVETA			0,15
TENSOR	 <p>VISTA FRONTAL</p>  <p>VISTA LATERAL</p>		0,10
GRAMPO			2,00
ESTICADOR			5,00
ESCORA SP		SP ESCORA 2 a 3,5 m	14,30
VIGAS	 <p>VISTA FRONTAL</p>  <p>VISTA LATERAL</p>	SPV 8,5 x 100	8,30
		SPV 8,5 x 150	11,00
		SPV 8,5 x 210	15,00
		SPV 8,5 x 260	19,00
		SPV 8,5 x 310	23,00
		SPV 8,5 x 360	27,00

PAINÉIS ESPECIAIS	REPRESENTAÇÃO	DIMENSÕES (cm)	PESO (kg)
Canto Interno		SPF CI - 20 x 100	9,50
Canto Externo			
Canto Curto		SPF CE - 14 x 100	4,00
Canto Longo			
Canto Duplo		SPF CC - 25 x 100	7,20
Guarda-Roda			
Raio Interno		SPF CL - 25 x 100	7,20
Raio Externo			
Angular de 10 cm		SPF CD - 21 x 100	7,15
Angular de 20 cm			
Circular de 40 cm ou de 60 cm		SPF CD - 28 x 100	7,80
		SPF GR - 30 x 100	7,90
			
		SPF RI - 6,5 x 100	4,00
		SPF RI - 6,5 x 125	5,00
		SPF RE - 8,5 x 100	4,00
		SPF RE - 8,5 x 125	5,00
		SPF AG - 10 x 100	4,50
		SPF AG - 20 x 100	6,00
		SPF CIRCULAR 40 x 100	14,00
		SPF CIRCULAR 60 x 100	25,50



SP - SISTEMA PROFICIENTE DE FORMAS LTDA.

Tels.: (21) 3882-3618 / 3882-3613 / 3882-3714

(11) 7737-9187 - ID: 12*19896

comercial@spformas.com.br

www.spformas.com.br